

H500

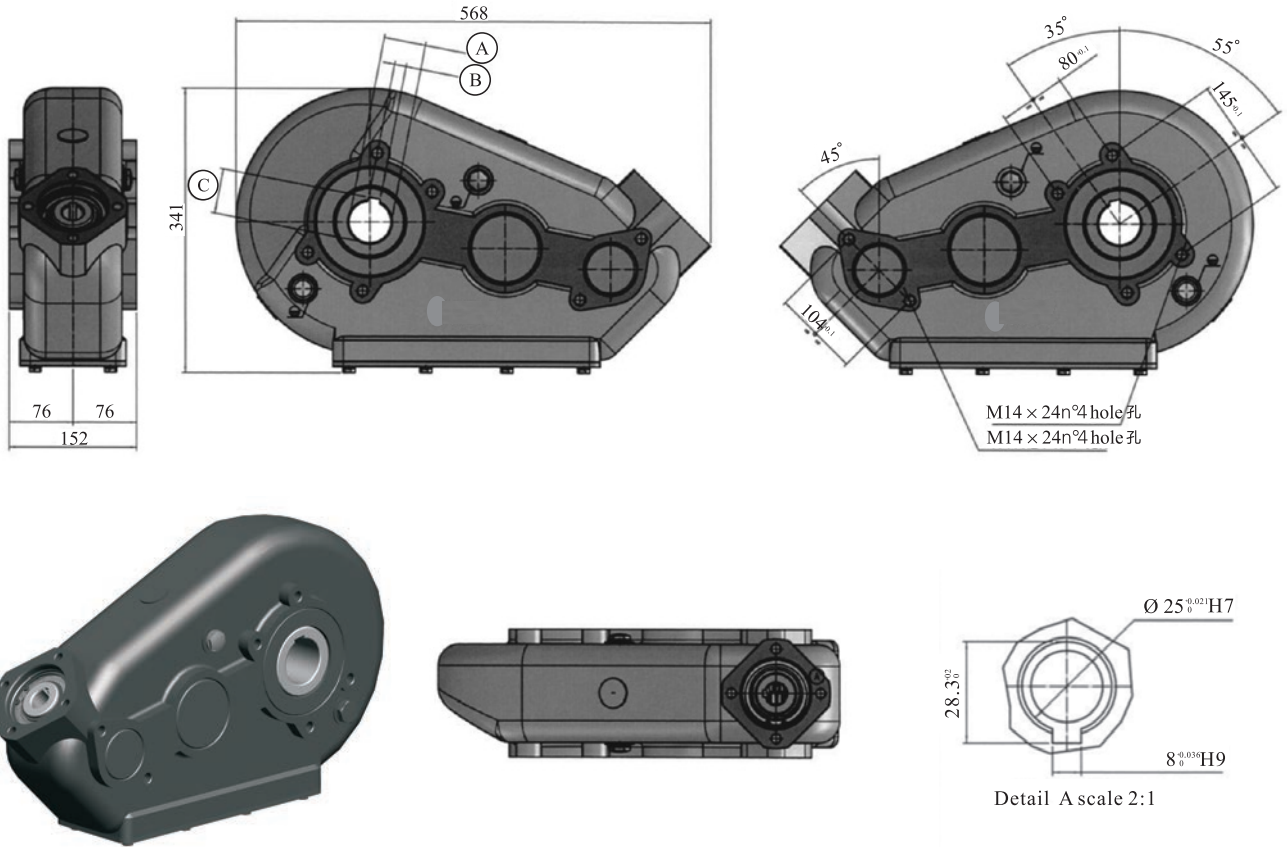

速比 Ratio	输出扭矩 Output torque N · m	重量 Weight Kg	润滑油 Lubrication	工作温度 Work temperature
43.6:1	5000	55	齿轮油 GEAR OIL CE80W90	-20° / +80°

A	B	C
Ø50	14	53,8
Ø55	16	59,3
Ø60	18	64,4